

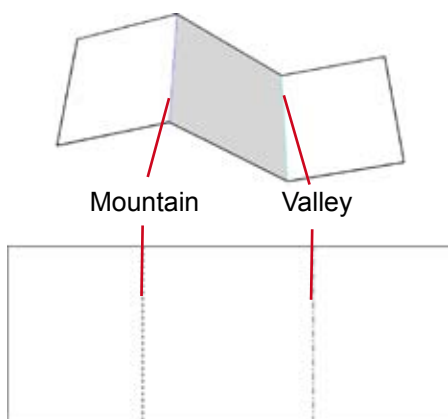

Help



8 Step number

Picture: Final assemblies are illustrated

Part numbers
 In black: Single parts
 In red: Left parts
 In green: Right parts

-  Apply glue on this area.
-  Cut this section.

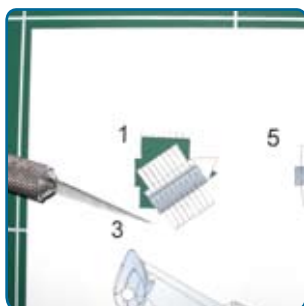

Stage 1
Cut the parts required in the step..



Stage 2
Fold the parts. Check mountain and valley foldings.



Stage 3
Glue the parts. The step is finished.

Use A4 Sheets of paper
 Size : 21*29.7mm
 Weight : 160 to 180 grs/M2
 Avoid too thin, fragile, and difficult to fold paper.

Ruler
 To be used to cut straight lines

Brush
 To apply glue on the paper

Cutter or blade
 Blade is preferred to make precise cuts.



White glue
 Preferable because it does not damage the ink on the paper.

Paper knife or flat object to fold the paper neatly

Tweezers to handle small parts

Felt tip pens to color the thickness of paper edges and the back of the wheels and rotor.

Glue a weight such as a wire, paperclip or a coin on the front edge.

1

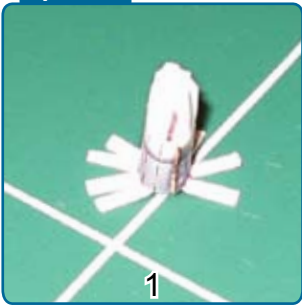

2

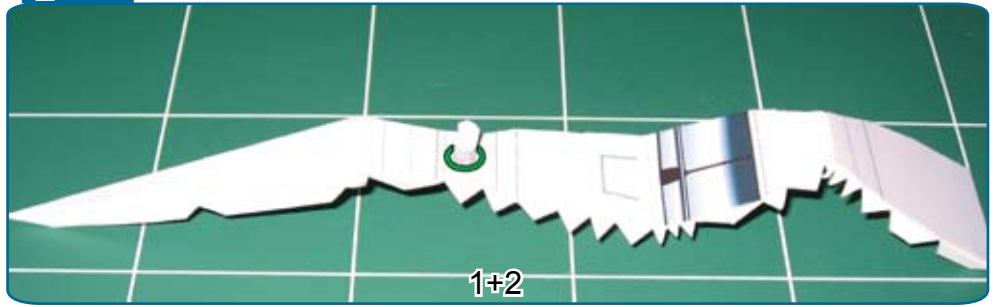

3

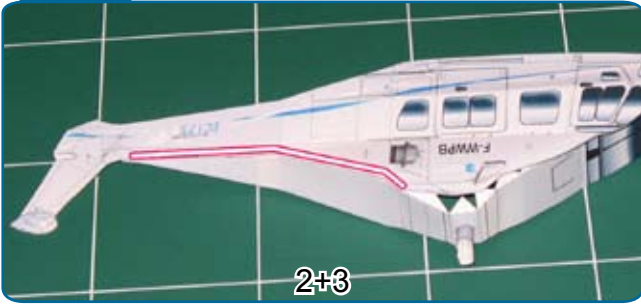

4



5

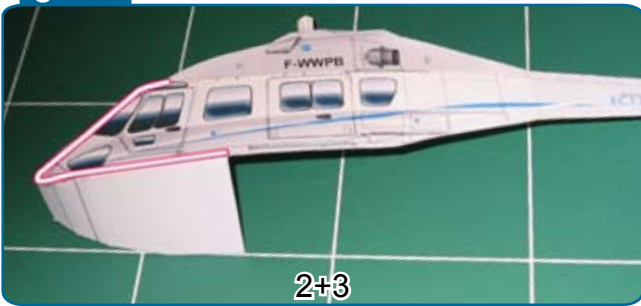

6



7

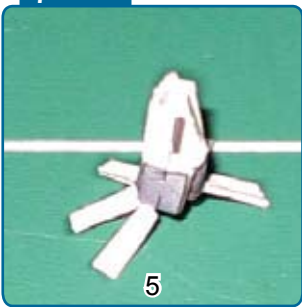

8



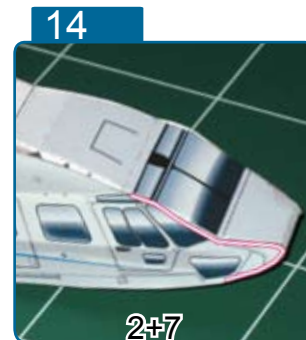
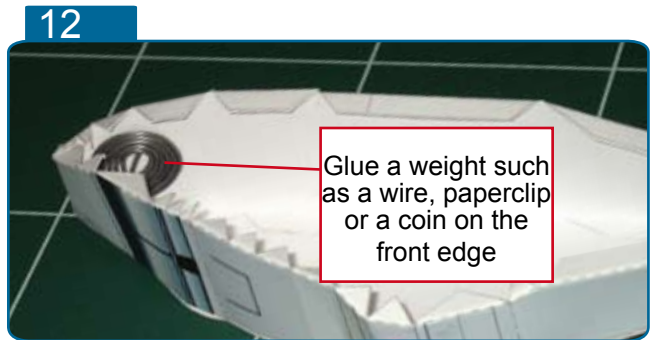
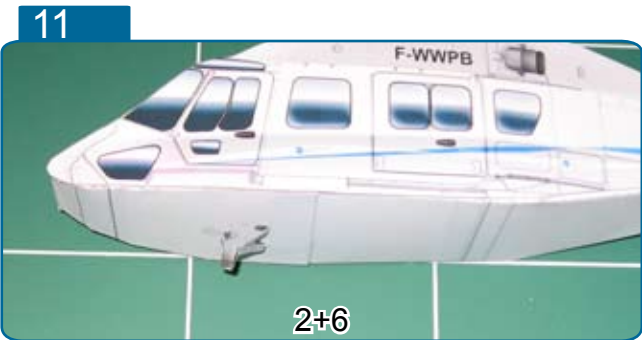
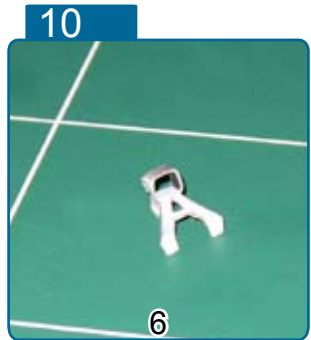

19



20



21



22

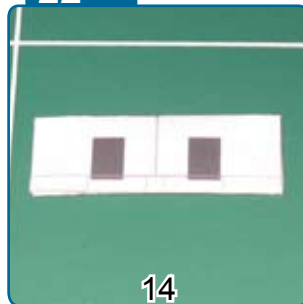

23

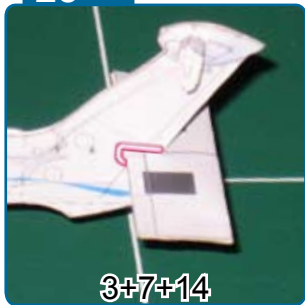

24



25



26



27

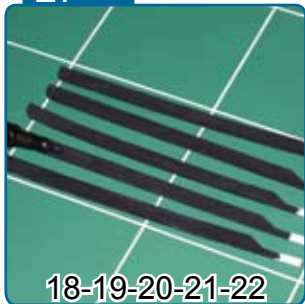

28



29

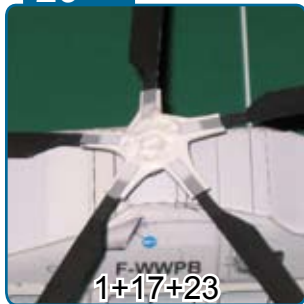

30



31



32



To be printed on 21*29.7mm (A4) - 160 to 180 grs/m2 paper

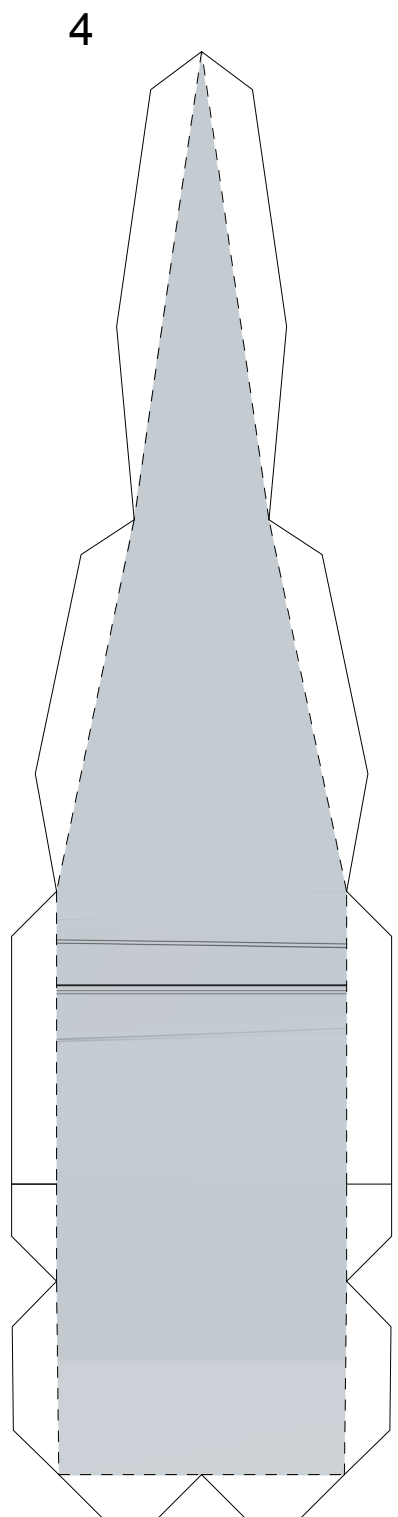
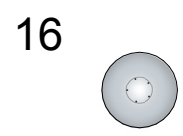
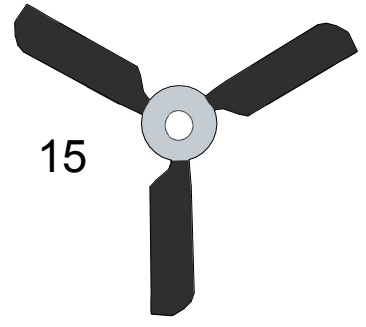
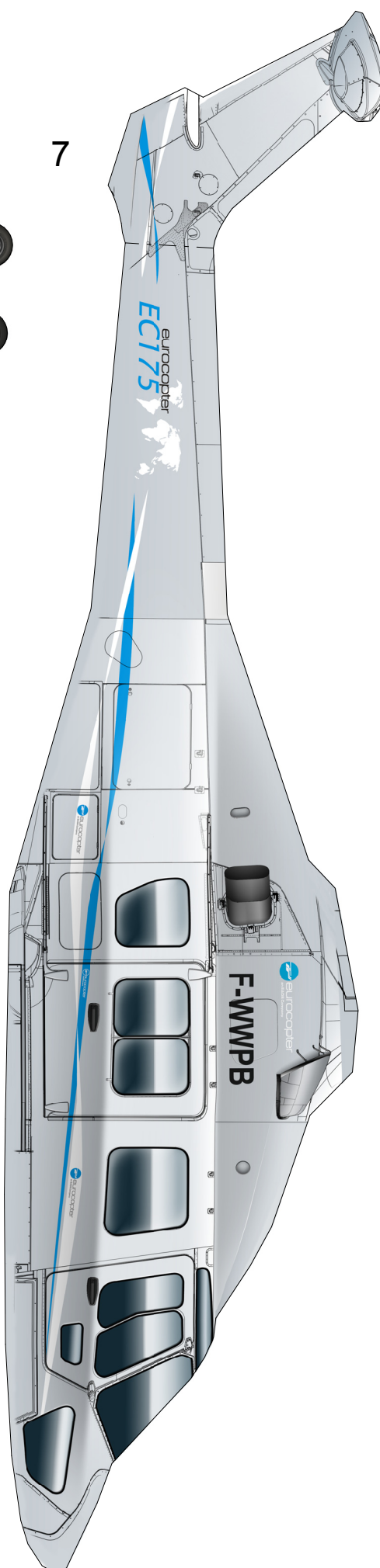
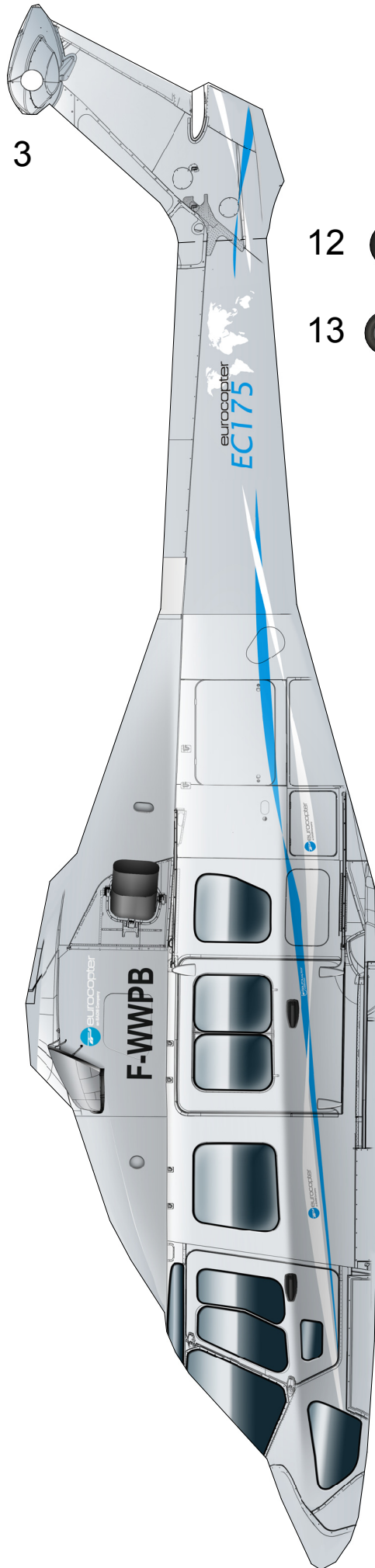

To be printed on 21*29.7mm (A4) - 160 to 180 grs/m2 paper

18
19
20
21
22

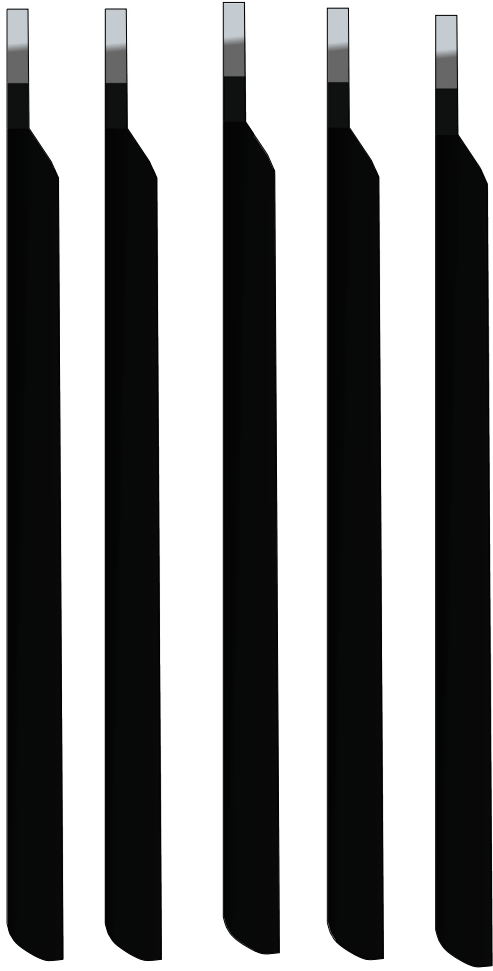

5

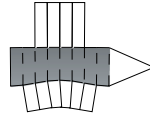

6

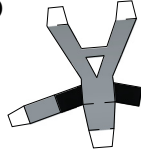

2

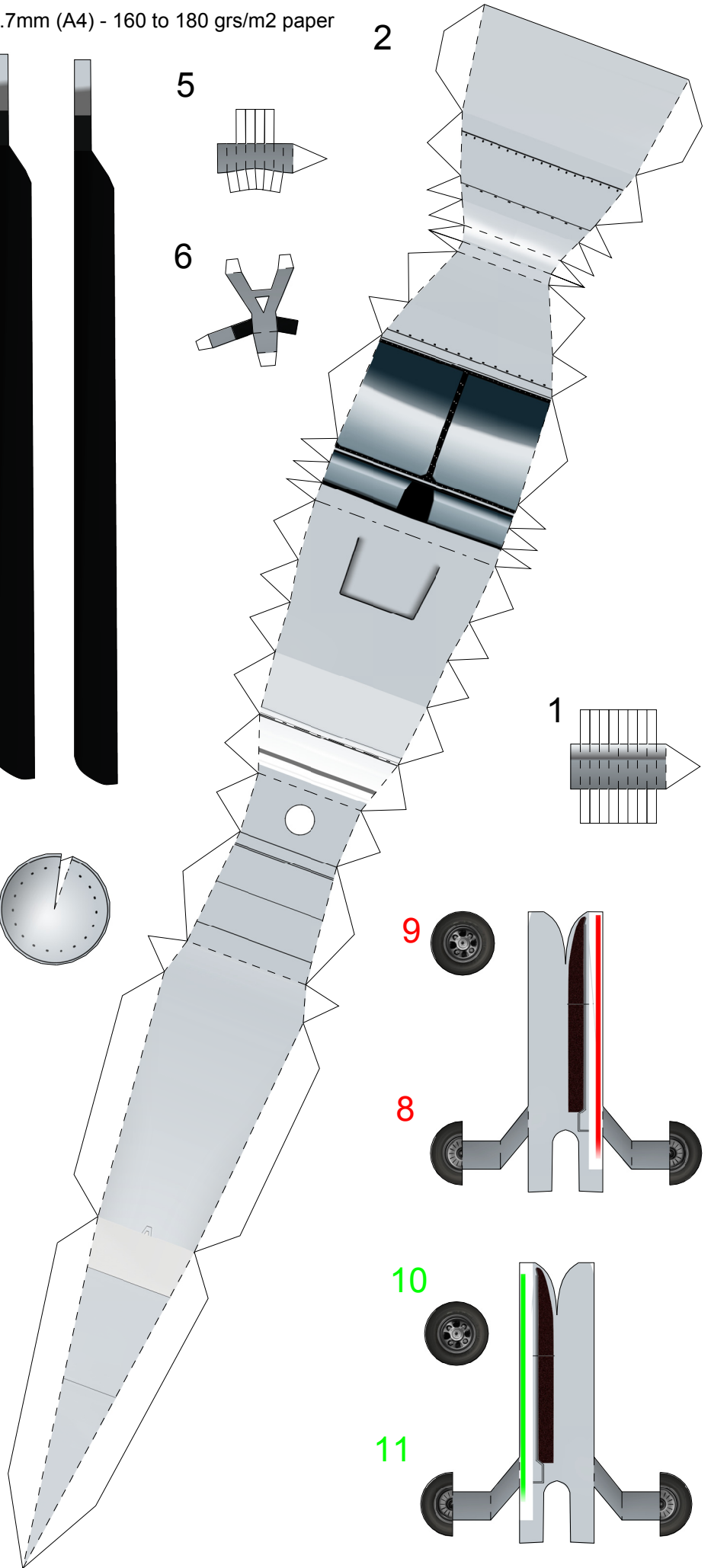

1

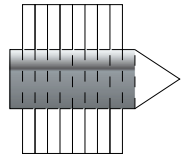

17

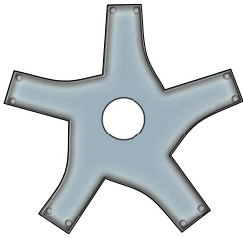

24

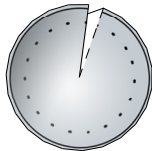

23

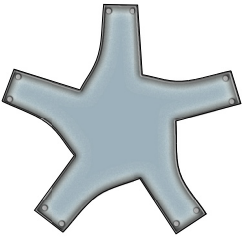

14

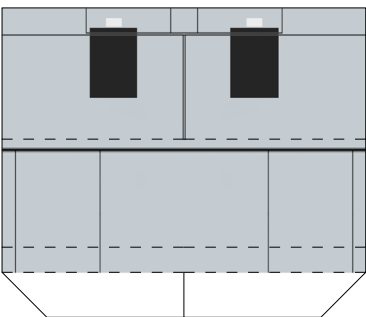

9



8

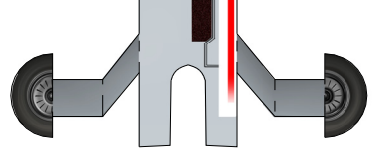

10



11

